

READ AND SAVE THESE INSTRUCTIONS

Cane Isle

Thank you for purchasing a Gulf Coast Fans, Inc. product. It will provide years of cost efficient comfort. With over a decade of experience in ensuring quality workmanship at an affordable price, we stand behind our product and we hope you will too.

IMPORTANT PRECAUTIONS

- 1** Read these instructions carefully before you start.
- 2** Turn off the power at the source before installation, servicing, or cleaning.
- 3** WARNING--TO REDUCE THE RISK OF FIRE OR ELECTRIC SHOCK, DO NOT USE THIS FAN WITH ANY SOLID STATE SPEED CONTROL DEVICE. USE ONLY GULF COAST CONTROLS.
- 4** WARNING--TO REDUCE THE RISK OF PERSONAL INJURY, DO NOT BEND THE BLADE IRONS WHEN INSTALLING ON BLADES, BALANCING THE BLADES, OR CLEANING THE FAN. DO NOT INSERT FOREIGN OBJECTS IN BETWEEN ROTATING FAN BLADES.
- 5** WARNING--TO REDUCE THE RISK OF FIRE, ELECTRIC SHOCK, OR PERSONAL INJURY, MOUNT FAN TO AN OUTLET BOX MARKED "ACCEPTABLE FOR FAN SUPPORT" AND USE MOUNTING SCREWS PROVIDED WITH THE OUTLET BOX.
- 6** If you don't feel comfortable hanging and wiring this fan, we recommend that you hire a qualified electrician to install it.
- 7** All wiring and electrical connections must meet the National Electrical Code and any local codes that may apply.
- 8** After installation, fan blades must be at least seven (7) feet from the floor.

To begin with, the site of installation must be clear of any obstructions. Walls, cabinet or cupboard doors, and AC/heating vents (strong air currents will cause fan to wobble) are common obstructions.

Also, you will need a securely mounted outlet box that is listed for fan support. You may also mount fan directly to a ceiling joist, but you must use a Ceiling Fan Swag Kit to provide power.

The only tools you will need are : A medium Phillips screwdriver, common sense, and a little caution.

- I. Inventory the parts. Remove all of the parts from the top styrofoam and remove the styrofoam. Use this top piece to support the fan during preliminary assembly.

A. Remove all parts from plastic bags, including the screw package.

Screw Package	
2- 3/16"-12x2" Wood Screws	
2- 3/8" Star Washers	
2- Flat Washers	
16- 3/16"-32x3/8" Blade Screws	
16- Blade Washer	
2- 1/8"-32x1/4" Canopy Screws	
3- Wirenuts	
11- Motor Screws	
1- Pull Chain Knob	

- B. Remove the three screws with the black shipping blocks from the motor and discard shipping blocks, if they are present.

- C. Remove two (2) 1/8"-32x1/4" screws from the switch cup plate on motor assembly. Loosen the remaining screw.

- D. Place the motor, switch cup plate down, in top styrofoam. Loosen two (2) 3/16"-28x1/2" set screws in coupler.

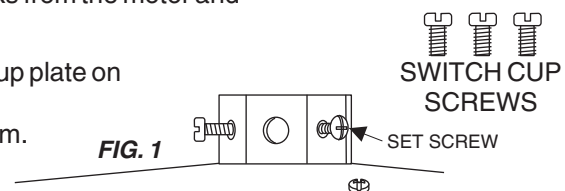

II Preliminary Assembly.

- A. Snap together blade and blade iron. Note the side of the blade you want to show. Using the 3/16"-32x3/8" blade screws, metal washers and paper washers, three of each per blade, secure blade to blade iron. Repeat this procedure with the rest of the blades. You will have at least one screw, one metal washer, and one paper washer left over; these are spares. Be sure all of the screws are tight. Fig. 2

- B.1. The downrod/ball combination may have a clevis pin, safety clip, and washer assembled on it. You will need to remove these to proceed. (If you are using a longer downrod than is provided, loosen the set screw on the ball, slide the ball down the downrod and remove. Replace the pin in the new downrod and slide the ball up so that the pin is in the slot in the ball. Tighten the set screw. Fig. 3.)

2. Place the downrod/ball combination through the canopy and top plate. Feed the fans wires through the downrod and insert downrod into coupler. Align the holes in the downrod with those in the coupler. Fig. 4

3. Insert the clevis pin and replace the washer and safety clip. Tighten the two set screws in the coupler.

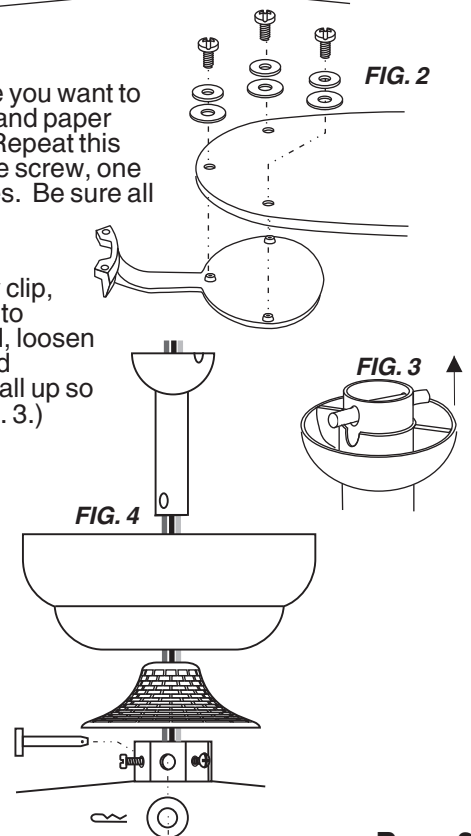

Make sure all of the screws are tight. At this time you may want to shorten the wires from the fan to 6" from the ball. This helps when you tuck the wires into outlet box.

WARNING - To Reduce The Risk Of Fire, Electric Shock, Or Personal Injury Mount Fan To Outlet Box Marked "Acceptable For Fan Support" And Use The Mounting Screws Provided With The Outlet Box.

C.1. Take the hanging bracket and secure it to the outlet box (marked Acceptable For Fan Support) using the mounting screws provided with the outlet box, Fig 5. Tighten them evenly. If you are using a swag kit, follow these instructions.

If you do not have an existing outlet box and do not wish to install one, you can use a ceiling fan swag kit. If you do, the hanging bracket must be secured directly to a ceiling joist.

First you will have to find the joist and mark the position. Now raise the hanging bracket to this position and align the holes in the bracket along the joist. Stencil these holes on the ceiling. Using a 1/8" drill bit, drill pilot holes into the joist. Secure the bracket to the joist using the large wood screws and washers provided in the screw package.

You may have to drill a hole in the canopy to accommodate the swag kit chain and wire. Some of our fans have a convenient 'punch-out' in the canopy. When wiring, use Method A.

2. Remove one canopy screw (also Fig 5) and loosen the other. Make sure all of the wires are accessible and are not being pinched. Also, make sure the bracket doesn't wobble.

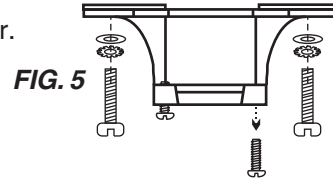

III. Now to hang the fan... Holding the fan carefully, lift it up to hanging bracket. Place the ball into cradle of the bracket. Turn the entire motor assembly until it locks into place. The tab on the bracket must be in the groove in the ball. See Fig. 6. Make sure the wires are not being pinched.

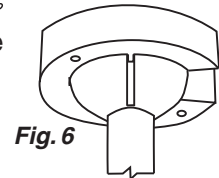

IV. Wiring methods and instructions.

There are three common wiring methods; choose the one best suited to your needs. Keep in mind, the supply wire colors may vary. (The wire colors in parentheses are commonly found in existing structures.) Use the large orange wirenuts to make the connections. It is a good idea to wire the blue light kit wire now, even if you don't have a light kit. It may save you some trouble in the future.

A. Pull chain operation only.

1. Green ground wires to outlet box ground (bare)
2. Black and blue wires from fan to hot supply (black)
3. White wire from fan to neutral supply (white)

See Fig 7.

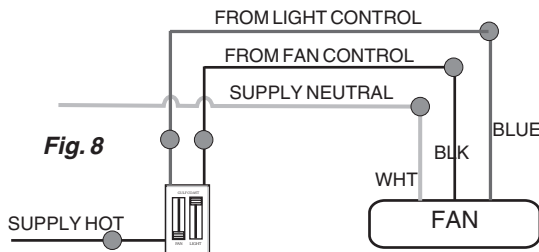
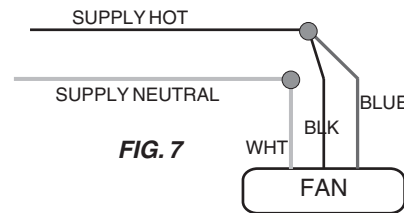

B. Wall control for both fan and light (Read the instructions for the wall control first.)

1. Green ground wires to outlet box ground. (bare)
2. Black wire from fan to (black) wire from fan control.
3. Blue wire from fan to (red) wire from light control.
4. White wire from fan to neutral supply. (white)

See Fig 8.

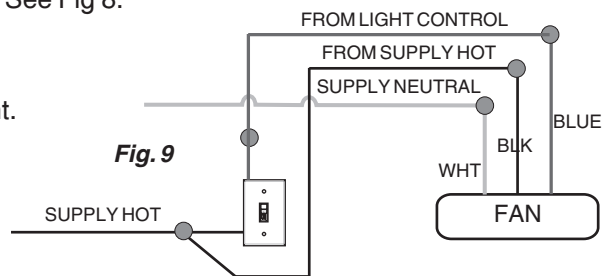

C. Pull chain operation of fan - Wall control for the light.

1. Green ground wires to outlet box ground. (bare)
2. Black wire from fan to hot supply. (black)
3. Blue wire from fan to (red) wire from wall control.
4. White wire from fan to neutral supply. (white)

See Fig 9.

Now tuck the wires and wirenuts carefully into outlet box. Make sure the Green and White wires are tucked into one side of the box and the Black and Blue wires are tucked into the other side of the box. Make sure wirenuts remain tightly on connections.

If you have a Gulf Coast Remote Control, fan should be wired according to method A.

Method B can be used with two separate controls for the fan and light, or with a combination wall control, such as a 423L Gulf Coast control.

V. Final Assembly

With the motor in place and the wires out of the way, slide the canopy up to the hanging bracket. The canopy screw in the bracket will come through the large end of the key slot in the canopy. Fig. 10. Turn the canopy slightly, counter-clockwise, to hold in place, and insert remaining canopy screw. Tighten the screws.

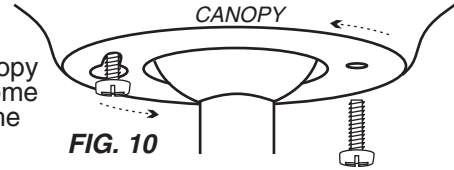

FIG. 10

VI. To avoid scratching the switch cup or damaging the motor, do not run the fan without blades. So, the next step is to mount the blade assemblies on the motor. The easiest way to do this is to balance a motor screw on the screwdriver, position blade arm aligning the two holes with the holes on the motor, and insert the screw. Fig. 11. Now insert another into the other hole and tighten both screws. Repeat this with the rest of the blade assemblies, and retighten all of the screws.

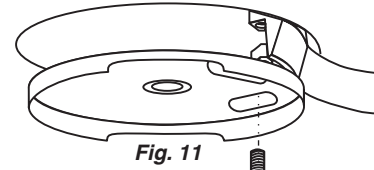

Fig. 11

VII. You're just about done now. The switch cup is the last step, and it's simple. Notice the wire connectors in the switch cup and on the motor. They are color coded and notched to fit only one way. Check the pins in both connectors for alignment as shown in Fig. 12. If they the pins are only slightly misaligned, bundle the wires tightly behind the connector when connecting. Push the connectors together until latch secures them together and make sure none of the pins were pushed out. Lift the cup into place. Insert one of the screws removed earlier and thread into switch cup plate. Insert the remaining switch cup screws and tighten all. Fig. 13.

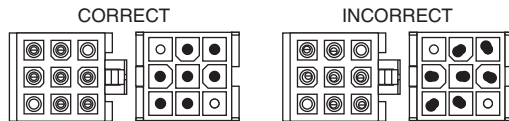

Fig. 12

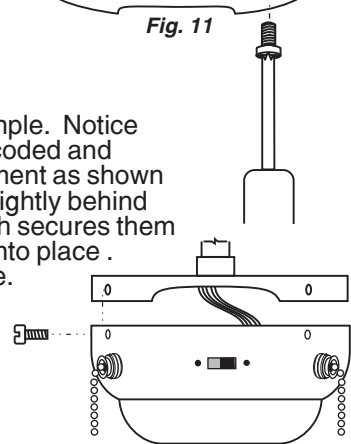

Fig. 13

VIII. Turn the power supply back on and prepare to be comfortable.

IX. The first pull of the chain will give you high speed. The second is medium speed, and the third is low speed. Once again will turn it off. With the reverse switch in the down position, the fan will provide downward air movement and positive air flow to cool you in the hot season. In the up position, air movement is upward and will bring heat trapped at the ceiling, down around the rooms walls, warming you in the cold season.

**** CAUTION - DO NOT ATTEMPT TO REVERSE FAN WHILE IT IS IN MOTION. ****

X. Troubleshooting	
Fan won't run -	Check power supply. Reverse switch is not fully engaged. Pin is pushed out of wire connector.
Fan makes noise - Allow 24 hrs. running time to seat bearings.	Screw(s) is(are) loose somewhere. Ball is not seated properly in hanging bracket. Variable speed control (dimmer) in circuit.
Fan wobbles -	Bracket is loose at the ceiling. Loose screw at top of fan. Ball not seated properly in hanging bracket. Try switching opposing blades. Try the blade balancing kit included.

We recommend that you retighten the blade iron to blade screws and blade iron to motor screws after fan has been up for 30 to 60 days.

Our service department is always ready to help. We stand behind our product and always strive to satisfy our customer.

Gulf Coast Fans, Inc.
300 Dunbar Avenue
Oldsmar, Florida 34677
(813)-855-7384

